



ArenaVision MVF403

MVF403 MHN-SA2000W A7 SI

ARENAVISION - MASTER MHN-SA - 2000 W

ArenaVision MVF403 takes sports floodlighting to the highest level, offering very high light output, optical efficiency, ease of installation, reliability and flexibility. It is ideal for indoor sports halls (1000 W version) as well as many outdoor sports and other lighting applications. The integrated system of oval optics and compact double-ended MHN-LA 1000W or MHN-SA HO 2000W lamps ensures outstanding system efficiency and low glare. A built-in reflector skirt reduces spill light and glare even further. The MHN-SA HO 2000W/956 and MHN-LA 1000W/956 lamps meet the highest international CTV requirements. With the MHN-LA 1000W/842 lamp, the natural colour rendering and comfortable atmosphere are well suited to TV and filming as well as other floodlighting applications. Hot re-strike versions are available for all lamp types, enabling immediate restoration of lighting after power supply failure. The (optional) flicker-free version of ArenaVision MVF403 MHN-LA 1000W is designed to ensure that the flicker effect is fully eliminated in order to guarantee perfect images filmed with super-slow-motion cameras at sports events. The flicker-free version of ArenaVision MVF403 comes equipped with a special electronic igniter, which works in combination with Philips' electronic ballast GearUnits (ECM330), to be ordered separately.

Product data

General Information	
Number of light sources	1 [1 pc]
Lamp family code	MHN-SA [MASTER MHN-SA]
Lamp power	2000 W
Kombipack	-
Gear	-
Optical cover/lens type	DOWN [Front-glass downlighting version]
Protection class IEC	Safety class I (I)

CE mark	CE mark
ENEC mark	ENEC mark
Optic type outdoor	Beam category A7
Aiming memory	-
Product family code	MVF403 [ARENAVISION]
Operating and Electrical	
Lamp supply voltage	400 V [400]

ArenaVision MVF403

Input Voltage	380 to 415 V
Ignitor	SI [Series]

Mechanical and Housing

Dimensions (height x width x depth) NaN x NaN x NaN mm (NaN x NaN x NaN in)

Approval and Application

Ingress protection code IP65 [Dust penetration-protected, jet-proof]

Mech. impact protection code IK08 [5 J vandal-protected]

Application Conditions

Ambient temperature range -30 to +35 °C

Product Data

Full product code	871829106951500
Order product name	MVF403 MHN-SA2000W A7 SI
EAN/UPC – product	8718291069515
Order code	910925432212
SAP numerator – quantity per pack	1
Numerator – packs per outer box	1
SAP material	910925432212
SAP net weight (piece)	14.500 kg

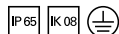

Dimensional drawing

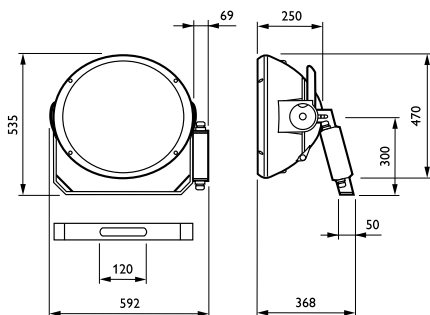

ArenaVision MVF403/MVF404

