



LuxSpace G4

DN590B LED15/840 PSD C D150 WH WB CAU

Reflector

LuxSpace Gen4 is the a new LED downlight range combining light comfort and leading performance with luxury appearance

Product data

General Information	
Lamp colour code	840 neutral white
Light source replaceable	No
Number of gear units	1 unit
Driver/power unit/transformer	PSU-E [Power supply unit external (PSU)]
Driver included	Yes
Optic type	Faceted reflector with beam angle 60°
Optical cover/lens type	Reflector
Control interface	DALI
Connection	Plug-in connector 3-pole Wieland/Adels compatible and 2x 2-pole control signal for light regulation
Protection class IEC	Safety class I (I)
Glow-wire test	650/30 [Temperature 650 °C, duration 30 s]
Flammability mark	F [For mounting on normally flammable surfaces]
CE mark	CE mark
Warranty period	3 years
Constant light output	No
Number of products on MCB (16 A type B)	24
EU RoHS compliant	Yes
Light source engine type	LED

Operating and Electrical	
Input Voltage	220 to 240 V
Input frequency	50 or 60 Hz
Inrush current	20.4 A
Inrush time	0.195 ms
Power factor (min.)	0.9

Controls and Dimming	
Dimmable	Yes

Mechanical and Housing	
Housing material	Aluminum die-cast
Reflector material	Polycarbonate aluminum coated
Optic material	Polycarbonate
Optical cover/lens material	Polycarbonate
Fixation material	Steel
Optical cover/lens finish	Textured
Overall length	0 mm
Overall width	0 mm
Overall height	100 mm
Overall diameter	162 mm

LuxSpace G4

Colour	White and black
--------	-----------------

Approval and Application

Ingress protection code	IP20 [Finger-protected]
Mech. impact protection code	IK03 [0.3 J]

Initial Performance (IEC Compliant)

Initial luminous flux (system flux)	1550 lm
Luminous flux tolerance	+/-10%
Initial LED luminaire efficacy	115 lm/W
Lamp colour temperature	4000 K
Colour Rendering Index	>80
Initial input power	13.5 W
Power consumption tolerance	+/-10%

Over Time Performance (IEC Compliant)

Median useful life L70B50	50000 h
Median useful life L80B50	50000 h

Median useful life L90B50	21000 h
---------------------------	---------

Application Conditions

Ambient temperature range	-20 to +40 °C
Maximum dimming level	1%

Product Data

Full product code	911401552241
Order product name	DN590B LED15/840 PSD C D150 WH WB CAU
Order code	911401552241
SAP numerator – quantity per pack	1
Numerator – packs per outer box	1
SAP material	911401552241
SAP net weight (piece)	0.799 kg



Dimensional drawing

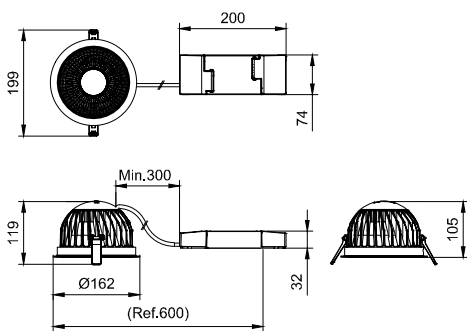

DN58XB/DN59XB

